

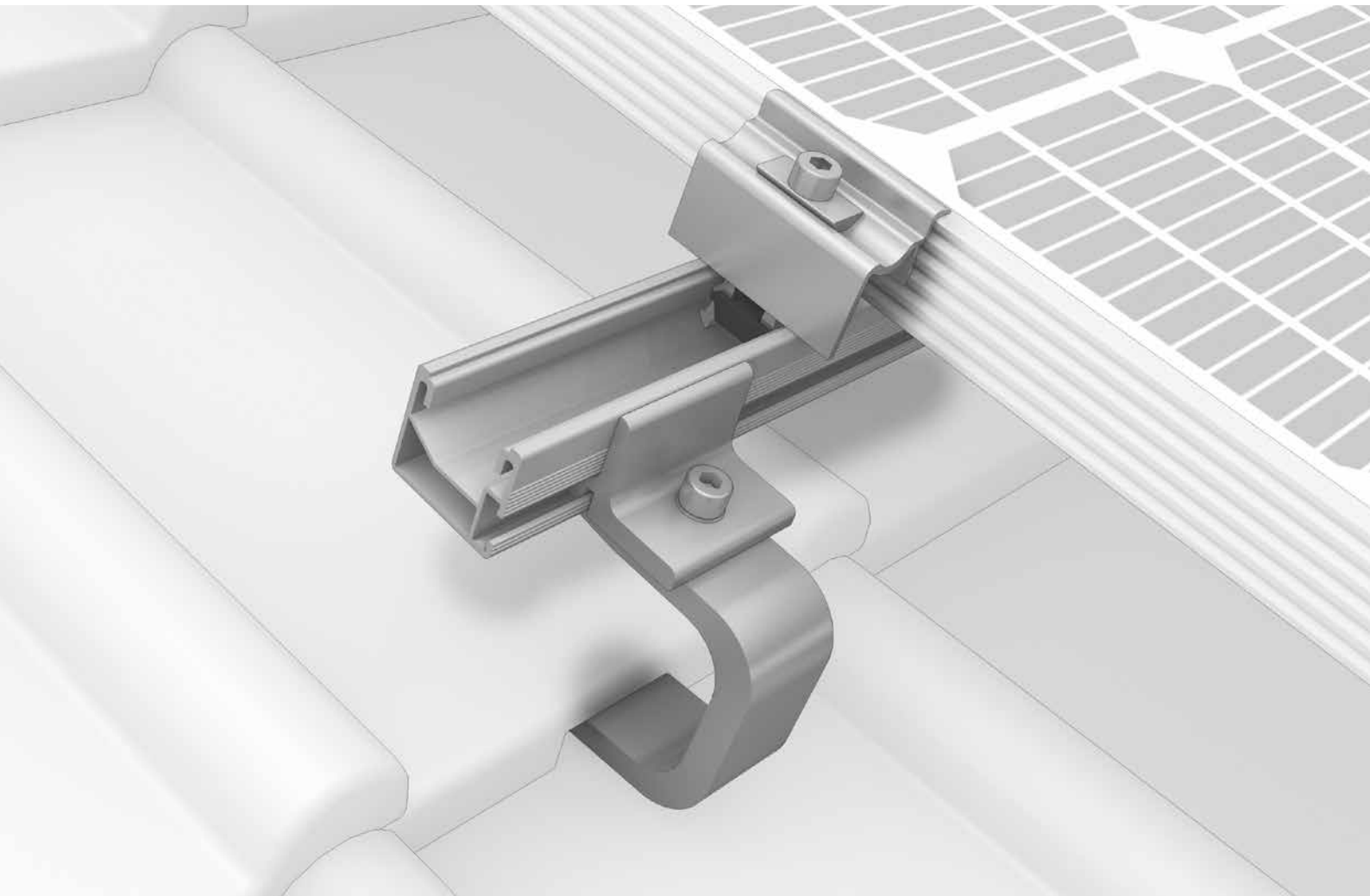

# SingleRail System



- / Quick and low-cost with direct lateral connections to the rail including customised height adjustment
- / Secure snap-in assembly - without needing to be screwed into the base plate
- / The SingleRail in combination with CrossHook roof hooks is very durable and versatile



# Roof fastenings

## Aluminium roof hooks

- / Optimum force transmission, can also be used on narrow rafters and direct connection to SingleRail
- / 80 % of all roof tiles and roofing stones covered
- / Simple height adjustment on base plate, extension arm or on slotted hole connection
- / CrossBoard/SingleBoard for rafter change
- / CrossHook 3S: With European construction approval ETA-16/0709

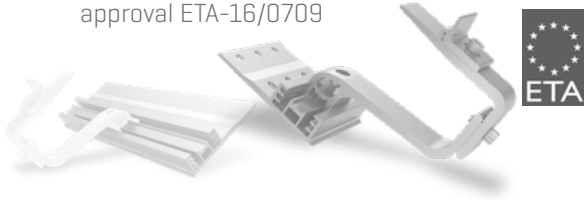

## Stainless steel roof hooks

- / High-quality, thin stainless steel outriggers and partly direct connection to SingleRail
- / For roof tiles, flat and pantiles
- / Height adjustable or many precisely fitting roof hooks with adapter connection from the SolidHook range

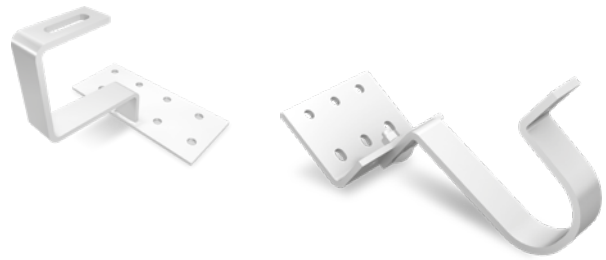

## Hanger bolts

- / For all corrugated fiber cement and corrugated sheet metal coverings with wooden substructure
- / Secure sealing at the roofing
- / With Climber connection
- / With German building authority approval [abZ]



## Sheet metal folding clamps

- / Many application possibilities: Double standing seam, angled seam, snap seam and round seam
- / Direct lateral rail connection
- / Penetration-free mounting

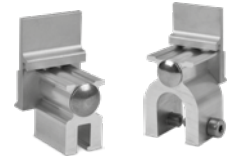

# Technical data

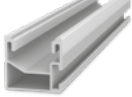
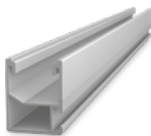
SingleRail	Light 36	36	50
Figure			
Material	Aluminium [EN AW-6063 T66]		
W = width [mm]	39.4	39.4	39
H = height [mm]	36	36	50
Lengths [m]	4.40	2.10 / 2.25 / 3.30 / 4.40 / 5.50	4.40
Weight [kg/m]	0.67	0.76	1.0
Second rail layer	SingleRail or SolidRail		

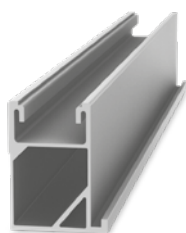
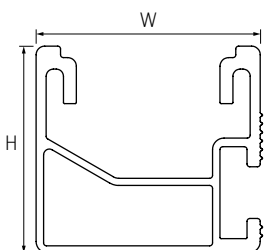

**SingleRail 63:** For heavy loads and large spans!



# SolidRail System

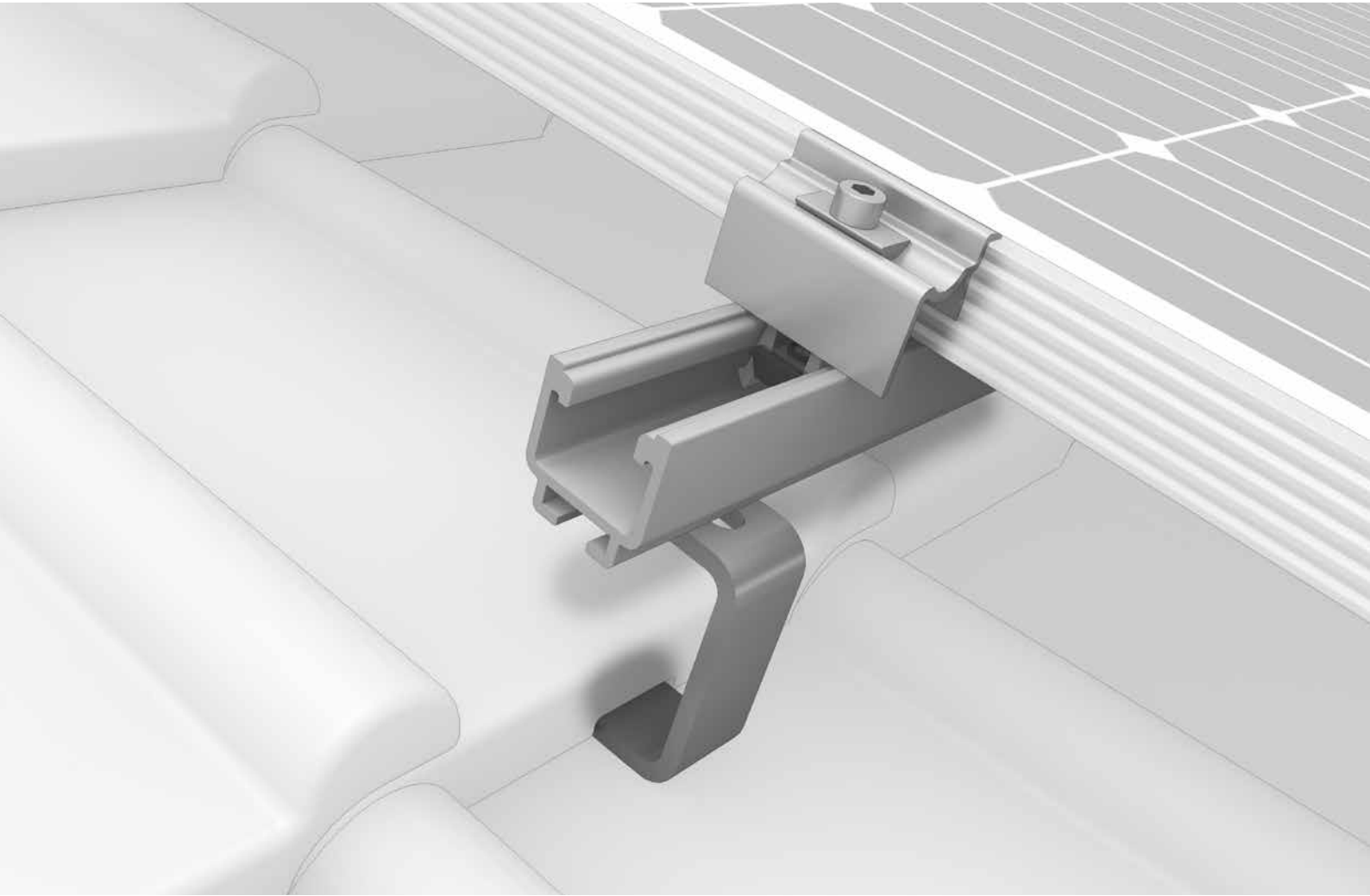

/ Comprehensive range of mounting rails for varying load profiles

/ Robust and structurally proven

/ High flexibility for a diverse range of widths



# Roof fastenings

## Stainless steel roof hooks

- / High-quality, thin stainless steel brackets with flexible adjustable connection even for narrow rafters
- / For pantiles, flat tiles and roof tiles
- / Height adjustable and many precisely fitting roof hooks

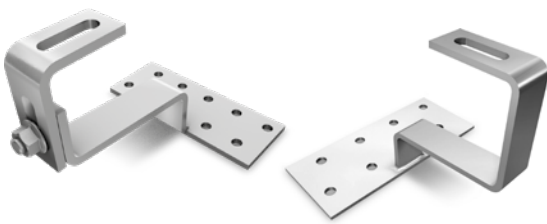

## Special roof hooks

- / Many application possibilities with the roof hooks for slate and beaver tail
- / Fastening on Coppo roofs is possible with the 1-fold height-adjustable SolidHook Coppo

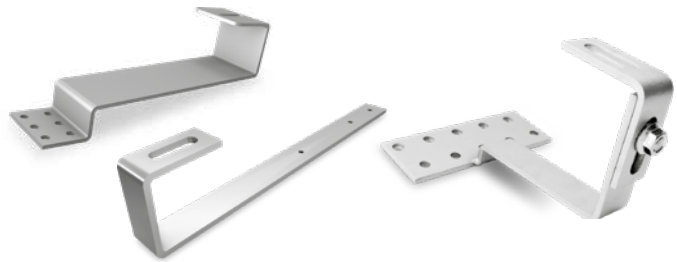

## Hanger bolts and solar fasteners

- / For all corrugated fiber cement, corrugated sheet metal and trapezoidal sheet metal coverings as well as sandwich panels
- / Secure sealing at the roofing
- / Connection via adapter plate with adjustment option
- / Hanger bolts with german building authority approval [abZ]





## Sheet metal folding clamps

- / Many application possibilities: Standing seam, angle seam, snap seam and round seam [e. g. Kalzip]
- / Rib-Roof solutions for 465, Speed 500 and Evolution
- / Penetration-free mounting

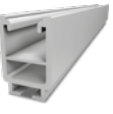

# Technical data

SolidRail	UltraLight 32	Light 37	Medium 42	Alpin 60
Figure				
Material	Aluminium [EN AW-6063 T66]			
W = width [mm]	39	39,5	41	41
H = height [mm]	32	37	42	60
Lengths [m]	2.10 / 2.25 / 3.30 / 4.40 / 5.50		4.40	5.50
Weight [kg/m]	0.7	0.85	1.3	1.7
Second rail layer	SingleRail or SolidRail			

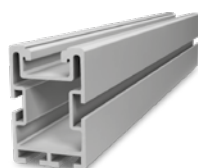
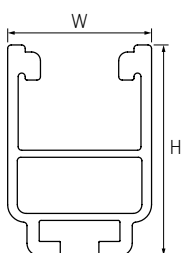

**SolidRail L:** For heavy loads across large widths!